

PROJECT	_____
TYPE	_____
SPECIFIER	_____
QUANTITY	_____
DATE	_____

ARCTIC CIRCLE SUSPENSION

D91232-

base number Finish
Options

- To build a product code in our configurator select the specify button on the base model # product page
- To build a manual product code on this datasheet choose from the options listed below in blue font and add the suffix to the base model #

GENERAL

Series: Arctic Circle _____
 Partner: Milan _____
 Division: Design _____
 Installation: Suspension _____
 Product Type: Pendant _____
 Mounting Location: Ceiling _____
 Light Distribution: Direct _____

PHYSICAL

Shape: Cone _____
 Diameter (mm): 350 _____
 Diameter (in): 13 ¾ _____
 Height (mm): 393 _____
 Height (in): 15 ½ _____
 Max. Overall Height (mm): 3000 _____
 Max. Overall Height (in): 118 ⅞ _____
 Diffuser: Opal Triplex acid-etched glass _____
 Fixture Finish: TUG / CRE _____
 Fixture Material: Ribbon / Aluminum _____
 Cable Details: 3000mm / 118 1/8" Cable _____

ELECTRICAL

Number of Lamps: 1 _____
 Lamp Type: LED Retrofit _____
 Bulb Included: Bulb Not Included _____
 Max. Wattage Per Lamp (W): 4.8 _____
 Lamp Base: G9 _____
 Input Voltage (V): 120 _____

LED

OPTICAL

RATINGS AND CERTIFICATIONS

Certified By: Certified for North American Standards _____
 IP rating: IP20 _____

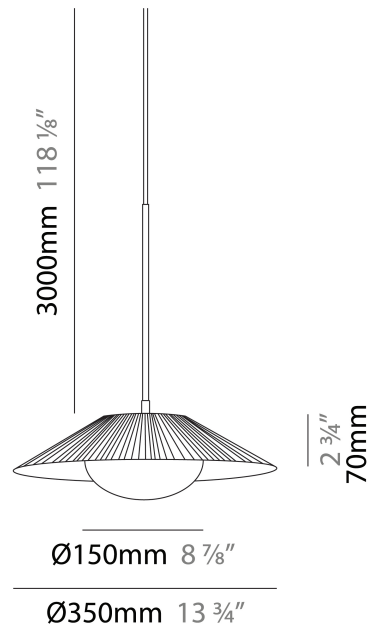

ARCTIC CIRCLE SUSPENSION

D91232-

PROJECT

TYPE

SPECIFIER

QUANTITY

DATE

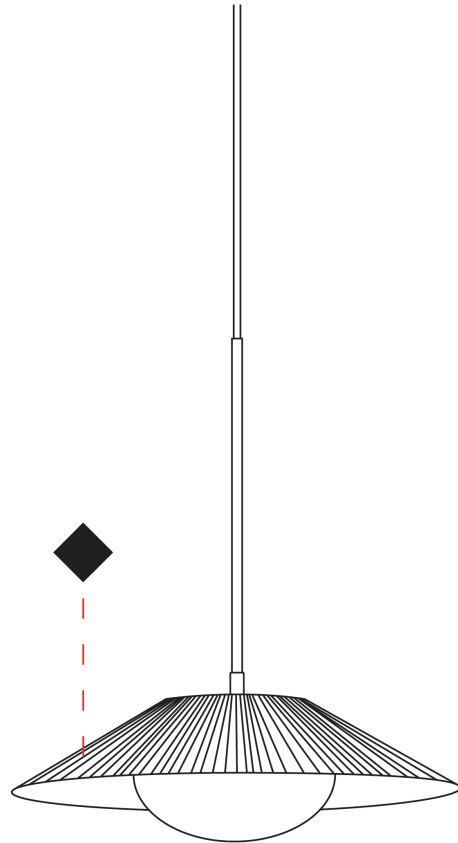

PROJECT	_____
TYPE	_____
SPECIFIER	_____
QUANTITY	_____
DATE	_____

ARCTIC CIRCLE SUSPENSION

D91233-

base number Finish
Options

- To build a product code in our configurator select the specify button on the base model # product page
- To build a manual product code on this datasheet choose from the options listed below in blue font and add the suffix to the base model #

GENERAL

Series: Arctic Circle
 Partner: Milan
 Division: Design
 Installation: Suspension
 Product Type: Pendant
 Mounting Location: Ceiling
 Light Distribution: Direct

PHYSICAL

Shape: Cone
 Diameter (mm): 450
 Diameter (in): 17 11/16
 Height (mm): 393
 Height (in): 15 1/2
 Max. Overall Height (mm): 3000
 Max. Overall Height (in): 118 1/8
 Diffuser: Opal Triplex acid-etched glass
 Fixture Finish: TUG / CRE
 Fixture Material: Ribbon / Aluminum
 Cable Details: 3000mm / 118 1/8" Cable

ELECTRICAL

Number of Lamps: 1
 Lamp Type: LED Retrofit
 Bulb Included: Bulb Not Included
 Max. Wattage Per Lamp (W): 4.8
 Lamp Base: G9
 Input Voltage (V): 120

LED

OPTICAL

RATINGS AND CERTIFICATIONS

Certified By: Certified for North American Standards
 IP rating: IP20

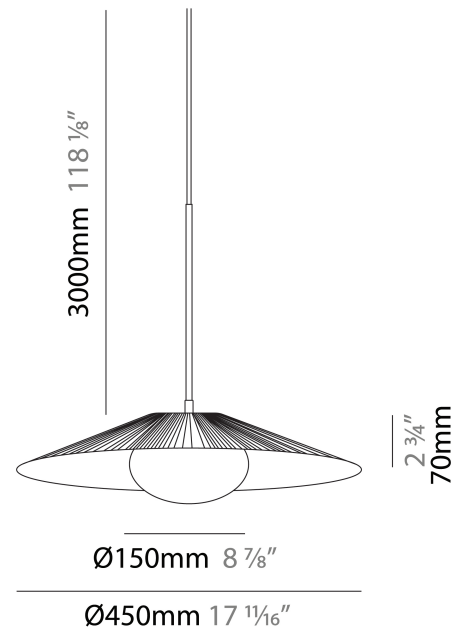

ARCTIC CIRCLE SUSPENSION

D91233-

PROJECT

TYPE

SPECIFIER

QUANTITY

DATE

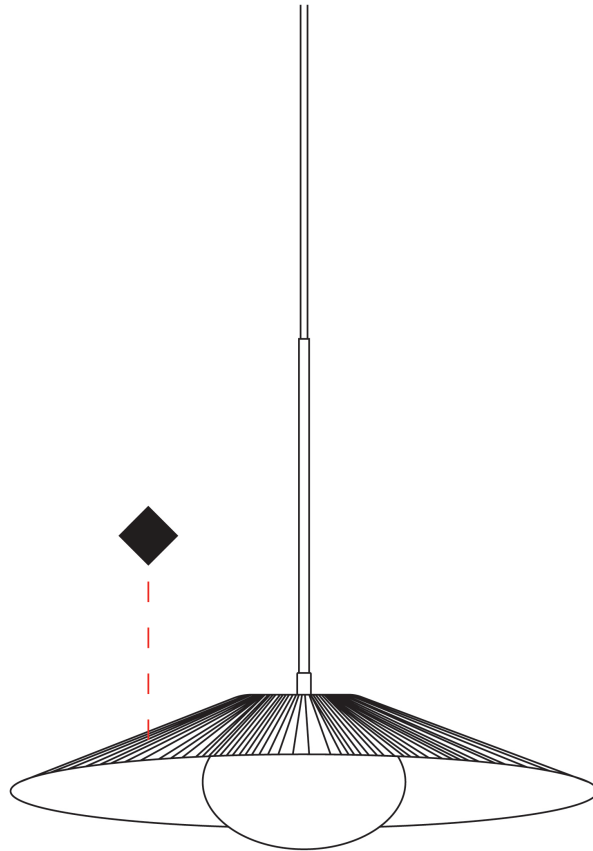

PROJECT	_____
TYPE	_____
SPECIFIER	_____
QUANTITY	_____
DATE	_____

ARCTIC CIRCLE SUSPENSION

D91234-

base number Finish
Options

- To build a product code in our configurator select the specify button on the base model # product page
- To build a manual product code on this datasheet choose from the options listed below in blue font and add the suffix to the base model #

GENERAL

Series: Arctic Circle
 Partner: Milan
 Division: Design
 Installation: Suspension
 Product Type: Pendant
 Mounting Location: Ceiling
 Light Distribution: Direct

PHYSICAL

Shape: Cone
 Diameter (mm): 550
 Diameter (in): 21 5/8
 Height (mm): 393
 Height (in): 15 1/2
 Max. Overall Height (mm): 3000
 Max. Overall Height (in): 118 1/8
 Diffuser: Opal Triplex acid-etched glass
 Fixture Finish: TUG / CRE
 Fixture Material: Ribbon / Aluminum
 Cable Details: 3000mm / 118 1/8" Cable

ELECTRICAL

Number of Lamps: 1
 Lamp Type: LED Retrofit
 Max. Wattage Per Lamp (W): 4.8
 Lamp Base: G9
 Input Voltage (V): 120

LED

Lamp Life (hrs): 50000

OPTICAL

RATINGS AND CERTIFICATIONS

Certified By: Certified for North American Standards
 IP rating: IP20

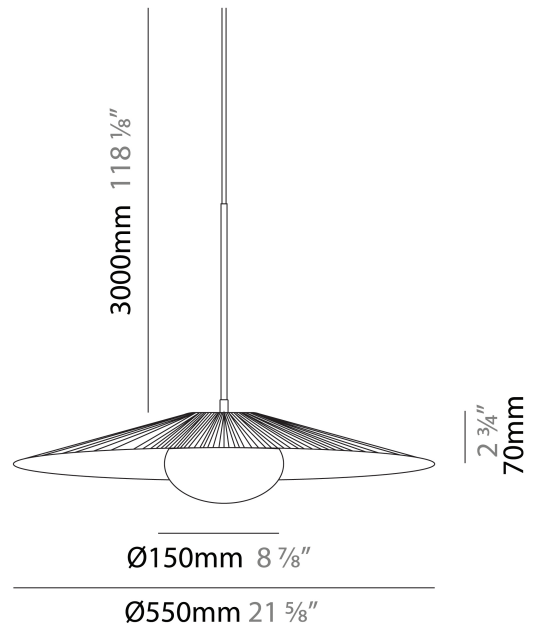

ARCTIC CIRCLE SUSPENSION

D91234-

PROJECT

TYPE

SPECIFIER

QUANTITY

DATE

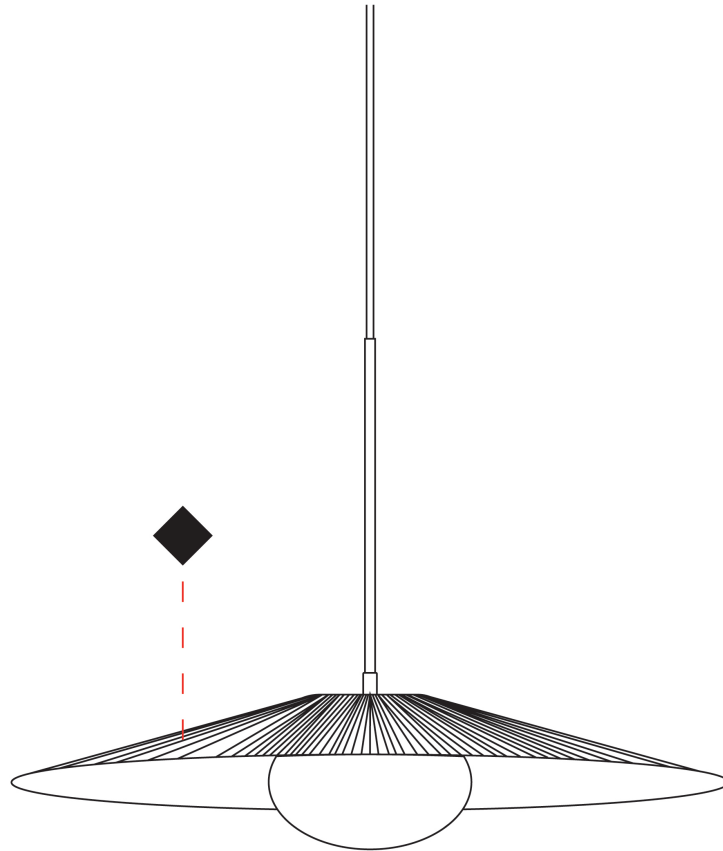

D

ARCTIC CIRCLE SURFACE

D93257-

base number _____
Finish _____
Options _____

1. To build a product code in our configurator select the specify button on the base model # product page
2. To build a manual product code on this datasheet choose from the options listed below in blue font and add the suffix to the base model #

GENERAL

Series: Arctic Circle _____
Partner: Milan _____
Division: Design _____
Installation: Surface _____
Product Type: Wall Surface _____
Mounting Location: Wall _____
Light Distribution: Direct _____

PHYSICAL

Shape: Cone _____
Diameter (mm): 350 _____
Diameter (in): 13 ¾ _____
Height (mm): 102 _____
Height (in): 4 _____
Diffuser: Opal Triplex acid-etched glass _____
Fixture Finish: TUG / CRE _____
Fixture Material: Ribbon / Aluminum _____

ELECTRICAL

Number of Lamps: 1 _____
Lamp Type: LED Retrofit _____
Bulb Included: Bulb Not Included _____
Max. Wattage Per Lamp (W): 4.8 _____
Lamp Base: G9 _____
Input Voltage (V): 120 _____

LED

OPTICAL

RATINGS AND CERTIFICATIONS

Certified By: Certified for North American Standards _____
IP rating: IP20 _____

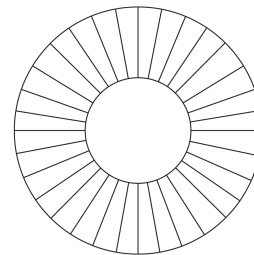
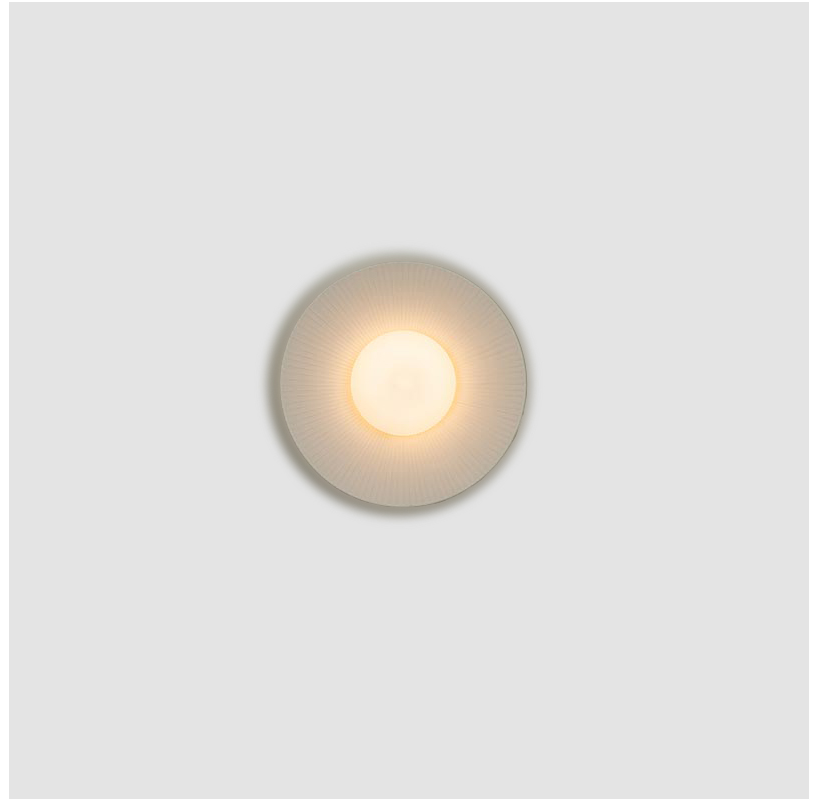

Ø350mm 13 ¾"



ARCTIC CIRCLE SURFACE

D93257-

PROJECT

TYPE

SPECIFIER

QUANTITY

DATE

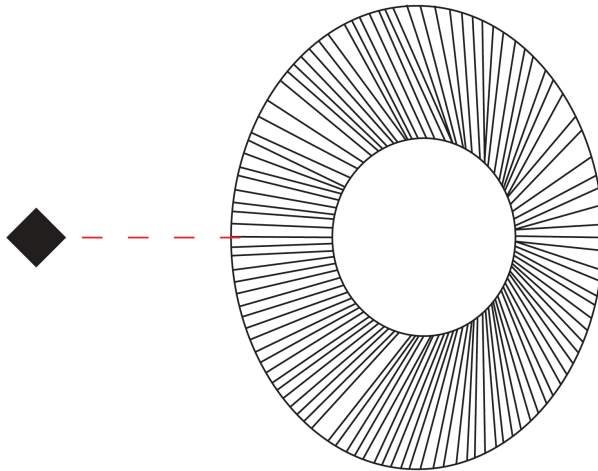

PROJECT	_____
TYPE	_____
SPECIFIER	_____
QUANTITY	_____
DATE	_____

ARCTIC CIRCLE SURFACE

D93258-

base number Finish
Options

1. To build a product code in our configurator select the specify button on the base model # product page
2. To build a manual product code on this datasheet choose from the options listed below in blue font and add the suffix to the base model #

GENERAL

Series: Arctic Circle _____
Partner: Milan _____
Division: Design _____
Installation: Surface _____
Product Type: Wall Surface _____
Mounting Location: Wall _____
Light Distribution: Direct _____

PHYSICAL

Shape: Cone _____
Diameter (mm): 450 _____
Diameter (in): 17 ¹¹/₁₆ _____
Height (mm): 102 _____
Height (in): 4 _____
Diffuser: Opal Triplex acid-etched glass _____
Fixture Finish: TUG / CRE _____
Fixture Material: Ribbon / Aluminum _____

ELECTRICAL

Number of Lamps: 1 _____
Lamp Type: LED Retrofit _____
Bulb Included: Bulb Not Included _____
Max. Wattage Per Lamp (W): 4.8 _____
Lamp Base: G9 _____
Input Voltage (V): 120 _____

LED

OPTICAL

RATINGS AND CERTIFICATIONS

Certified By: Certified for North American Standards _____
IP rating: IP20 _____

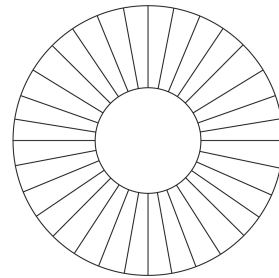
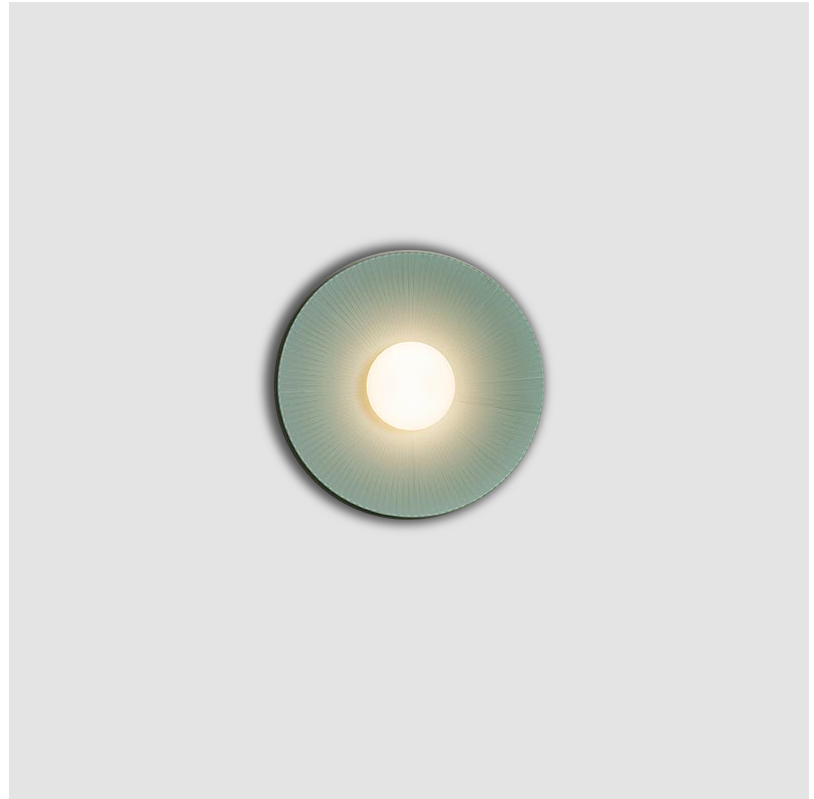

Ø450mm 17 ¹¹/₁₆"



ARCTIC CIRCLE SURFACE

D93258-

PROJECT

TYPE

SPECIFIER

QUANTITY

DATE

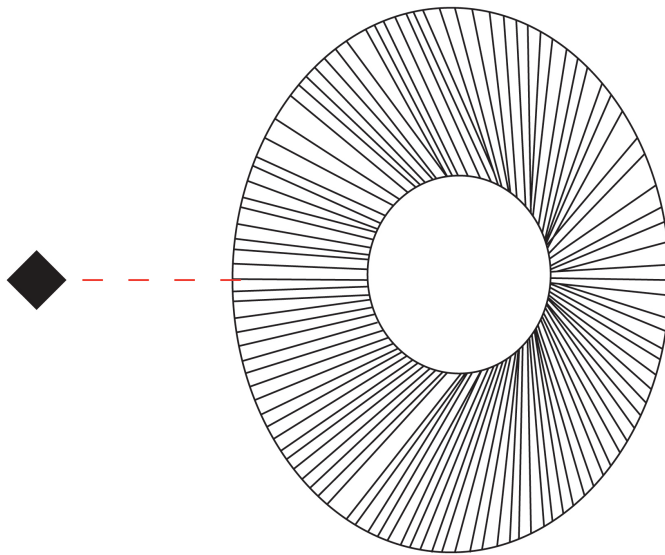

PROJECT	_____
TYPE	_____
SPECIFIER	_____
QUANTITY	_____
DATE	_____

ARCTIC CIRCLE SURFACE

D93259-

base number Finish
Options

1. To build a product code in our configurator select the specify button on the base model # product page
2. To build a manual product code on this datasheet choose from the options listed below in blue font and add the suffix to the base model #

GENERAL

Series: Arctic Circle
Partner: Milan
Division: Design
Installation: Surface
Product Type: Wall Surface
Mounting Location: Wall
Light Distribution: Direct

PHYSICAL

Shape: Cone
Diameter (mm): 550
Diameter (in): 21 5/8
Height (mm): 102
Height (in): 4
Diffuser: Opal Triplex acid-etched glass
Fixture Finish: TUG / CRE
Fixture Material: Ribbon / Aluminum

ELECTRICAL

Number of Lamps: 1
Lamp Type: LED Retrofit
Bulb Included: Bulb Not Included
Max. Wattage Per Lamp (W): 4.8
Lamp Base: G9
Input Voltage (V): 120

LED

OPTICAL

RATINGS AND CERTIFICATIONS

Certified By: Certified for North American Standards
IP rating: IP20

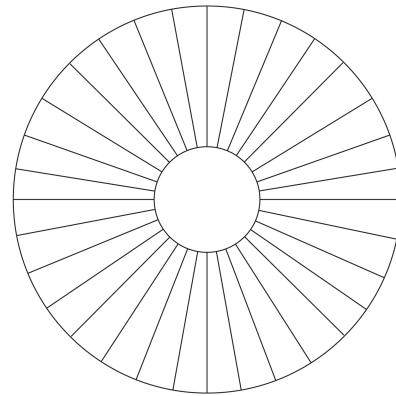
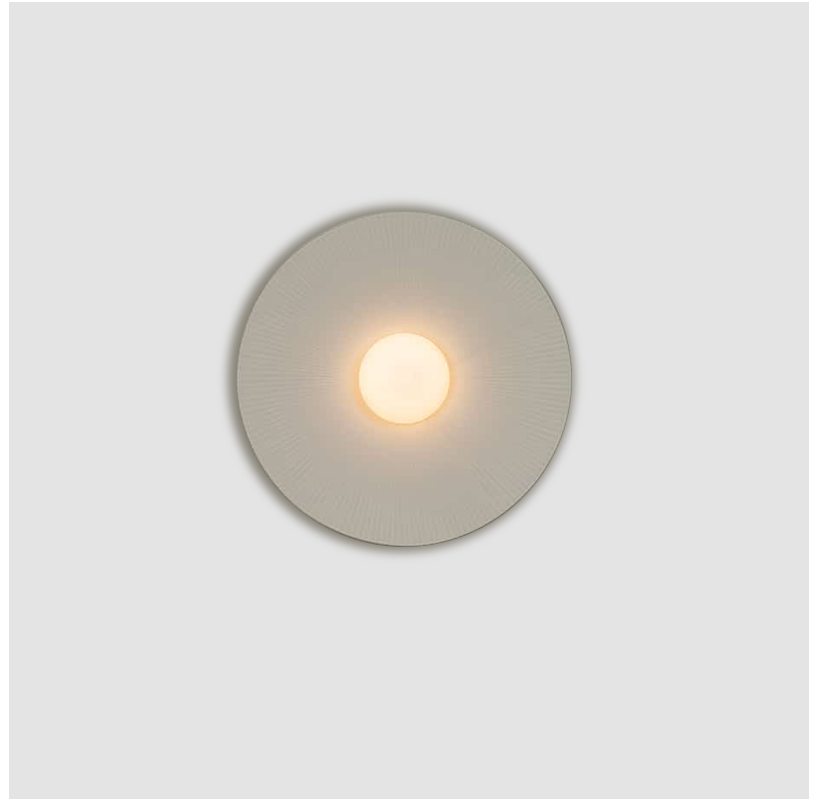

Ø550mm 21 5/8"



ARCTIC CIRCLE SURFACE

D93259-

PROJECT

TYPE

SPECIFIER

QUANTITY

DATE

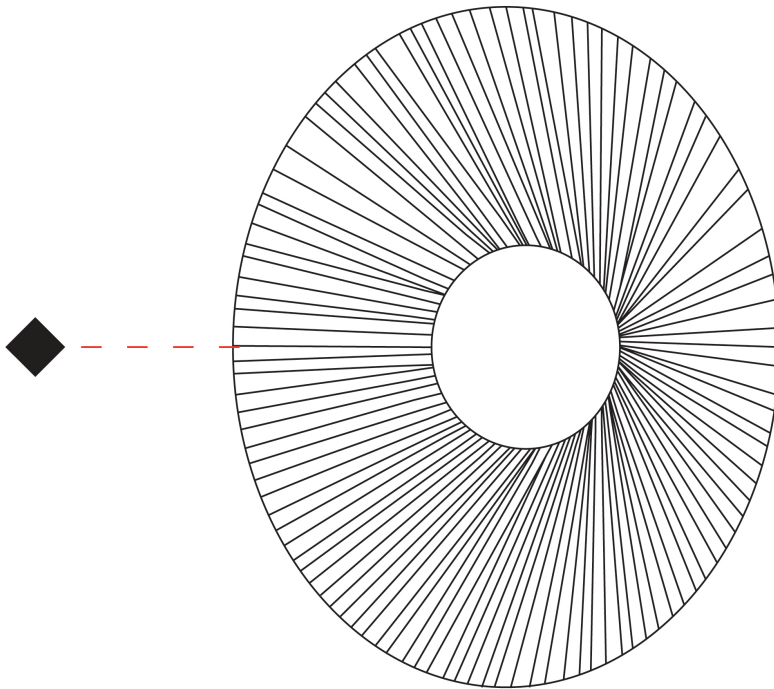

ARCTIC CIRCLE COLOR FINISH CHART

PROJECT

TYPE

SPECIFIER

QUANTITY

DATE

Fixture Finish

Turquoise Green - TUG

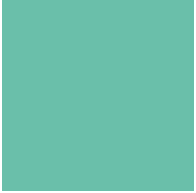

Cream - CRE

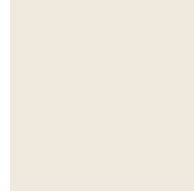

Digital: Not all screens are calibrated the same, and therefore, colors will appear differently between screens.

Physical: When texture is involved, there will be variations in color, character and tone within a product series and between product families.



LEGEND

	floor-mounted		pivotal		special LED (upon request) RGB, RGBW, tunable, gold+, meat+, art+, fashion+
	wall and ceiling: recessed and surface mounted		rotating		warm dim / natural dimming LED
	ceiling-mounted and wall-mounted		illuminate tilted		rechargeable battery powered
	wall-mounted		color of suspension cable		fixture with natural vivid LED (upon request)
	omni-directional light distribution		length of suspension cable		color rendering index
	direct light distribution		reflector degree selection		color temperature
	direct/indirect light distribution		super spot		lumen (luminous flux)
	indirect light distribution		lens		efficacy (lumens per watt)
	asymmetric light distribution		lens pack		Unified Glare Rating (UGR) range from 5-40
	aura light distribution		shine ring		marine grade (AISI 316 stainless steel)
	round wall or ceiling cut-out		integrated shine ring with diffuser		walk on
	square wall or ceiling cut-out		free individual colors 01-29		drive on
	the supplied jig specifies the cutout dimensions		individual colors: 00 (free of charge), 01-25 (extra charge)		Dark Sky Compliance
	minimum distance (meters) lamp - object		luminaire part to be colored (F1)		Americans with Disabilities Act (less than 4" off the wall located between 27"-84" from floor)
	recessed depth		luminaire part to be colored (F2)		lamp protected against explosion
	ceiling thickness in mm		luminaire part to be colored (F3)		blown glass using traditional methods by master glass blower
	ceiling thickness selection		luminaire part to be colored (F4)		acoustic material
	dimmable DP (phase), DV (0-10V), DD (dali), DS (step-dim)		luminaire part to be colored (F5)		protection class I, protection insulation
	included or excluded LED driver/transformer/control gear		color of 3-circuit adaptor		protection class II, protection insulation
	separately switchable		indirect diffuser		ETL Certified to UL and CSA Standards
	sensor		direct diffuser		UL Certified to UL and CSA Standards
	remote control		ball-proof (upon request)		CSA Certified to UL and CSA Standards
	available upon request		accessory		Certified for North American Standards

IP RATING

	protected against ingress of solid bodies greater than 12.5mm (finger)
	protected against ingress of solid bodies greater than 2.5mm protected against sprays of water up to 60 degrees from the vertical (rain)
	protected against ingress of solid bodies greater than 1mm (wire) no protection against the ingress of moisture
	protected against ingress of solid bodies greater than 1mm (wire) protected against sprays of water up to 60 degrees from the vertical (rain)
	protected against ingress of solid bodies greater than 1mm (wire) protected against water splashed from all directions
	protected against limited ingress of dust (wet rooms/covered outdoor areas) protected against water splashed from all directions
	protected against ingress of dust protected against jets of water
	protected against ingress of dust protected against powerful jets of water or heavy seas
	protected against ingress of dust protected against immersion of water between 15cm - 1m for 30 minutes
	protected against ingress of dust protected against immersion of water under pressure for long periods

IK RATING

	protected against 0.14 joules impact (equivalent to 0.25kg mass dropped from 56mm above the surface)
	protected against 0.2 joules impact (equivalent to 0.25kg mass dropped from 80mm above the surface)
	protected against 0.35 joules impact (equivalent to 0.25kg mass dropped from 140mm above the surface)
	protected against 0.5 joules impact (equivalent to 0.25kg mass dropped from 200mm above the surface)
	protected against 0.7 joules impact (equivalent to 0.25kg mass dropped from 280mm above the surface)
	protected against 1 joules impact (equivalent to 0.25kg mass dropped from 400mm above the surface)
	protected against 2 joules impact (equivalent to 0.5kg mass dropped from 400mm above the surface)
	protected against 5 joules impact (equivalent to 1.7kg mass dropped from 300mm above the surface)
	protected against 10 joules impact (equivalent to 5.0kg mass dropped from 200mm above the surface)
	protected against 20 joules impact (equivalent to 5.0kg mass dropped from 400mm above the surface)